

RIEGL VQ[®]-480i

- **high-accuracy ranging based on echo digitization and online waveform processing**
- **high laser repetition rate - fast data acquisition**
- **multiple target capability - unlimited number of targets**
- **perfectly linear scan lines**
- **compact, rugged, and lightweight design**
- **electrical interfaces for GPS data string and Sync Pulse (1PPS)**
- **mechanical interface for IMU mounting**
- **integrated LAN-TCP/IP interface**

The V-Line[®] Airborne Laser Scanner *RIEGL VQ-480i* provides high speed data acquisition using a narrow infrared laser beam and a fast line scanning mechanism. High-accuracy laser ranging is based on *RIEGL*'s unique echo digitization and online waveform processing, which allows achieving superior measurement results even under adverse atmospheric conditions, and the evaluation of multiple target echoes.

The scanning mechanism is based on a fast rotating multi-facet polygonal mirror, which provides fully linear, unidirectional and parallel scan lines.

The *RIEGL VQ-480i* is a very compact and lightweight scanner, mountable in any orientation and even under limited space conditions on helicopters or UAVs. The instrument requires only one power supply and provides line scan data via the integrated LAN-TCP/IP interface. The binary data stream can easily be decoded by user-designed software making use of the available software library RIVLib.

Typical applications include

- *Corridor Mapping*
- *Power Line Inspection*
- *Cultural Heritage Mapping*



visit our website
www.riegl.com

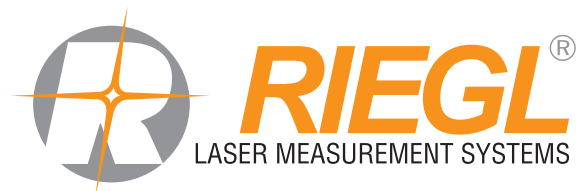

Technical Data RIEGL VQ®-480i

Laser Product Classification

Class 1 Laser Product according to IEC60825-1:2007

The following clause applies for instruments delivered into the United States: Complies with 21 CFR 1040.10 and 1040.11 except for deviations pursuant to Laser Notice No. 50, dated June 24, 2007.



Range Measurement Performance

Measuring Principle

time of flight measurement, echo signal digitization, online waveform processing, multiple-time-around-processing

Laser Pulse Repetition Rate PRR ¹⁾	50 kHz	100 kHz	200 kHz	300 kHz	400 kHz	550 kHz
Effective Measurement Rate (meas./sec.) ^{1) 2)}	25 000	50 000	100 000	150 000	200 000	275 000
Max. Measuring Range ^{3) 4)}						
natural targets $\rho \geq 20\%$	1300 m	950 m	650 m	550 m	500 m	400 m
natural targets $\rho \geq 60\%$	2100 m	1550 m	1100 m	950 m	800 m	700 m
Max. Operating Flight Altitude AGL ^{1) 2)}	1050 m (3450 ft)	750 m (2450 ft)	550 m (1800 ft)	450 m (1450 ft)	400 m (1300 ft)	300 m (1000 ft)
Max. Number of Targets per Pulse	practically unlimited (details on request)					

1) Rounded values.
 2) Reflectivity $\rho \geq 20\%$, $\pm 30^\circ$ FOV, additional roll angle $\pm 5^\circ$.
 3) Typical values for average conditions. Maximum range is specified for flat targets with size in excess of the laser beam diameter, perpendicular angle of incidence, and for atmospheric visibility of 23 km. In bright sunlight, the max. range is shorter than under overcast sky.
 4) Ambiguity to be resolved by post-processing with RIMTA ALS software.

Minimum Range

Accuracy ^{5) 7)}

Precision ^{6) 7)}

Laser Pulse Repetition Rate ^{1) 8)}

Max. Effective Measurement Rate ¹⁾

Echo Signal Intensity

Laser Wavelength

Laser Beam Divergence ⁹⁾

Laser Beam Footprint (Gaussian Beam Definition)

10 m

20 mm

20 mm

up to 550 kHz

up to 275 000 meas./sec. (@ 550 kHz PRR & 60° FOV)

for each echo signal, high-resolution 16 bit intensity information is provided

near infrared

0.3 mrad

31 mm @ 100 m, 75 mm @ 250 m, 150 mm @ 500 m

- 5) Accuracy is the degree of conformity of a measured quantity to its actual (true) value.
 6) Precision, also called reproducibility or repeatability, is the degree to which further measurements show the same result.

- 7) One sigma @ 150 m range under RIEGL test conditions.
 8) User selectable.
 9) Measured at the 1/e² points. 0.30 mrad corresponds to an increase of 30 mm of beam diameter per 100 m distance.

Scanner Performance

Scanning Mechanism

Field of View (selectable)

Scan Speed (selectable)

Angular Step Width $\Delta \theta$ (selectable)

between consecutive laser shots

Angle Measurement Resolution

Internal Sync Timer

Scan Sync (optional)

rotating polygon mirror

60° (+30° / -30°)

10 - 150 scans/sec

0.002° $\leq \Delta \theta \leq 0.36^\circ$

0.001°

for real-time synchronized time stamping of scan data

scanner rotation synchronization

Data Interfaces

Configuration

Scan Data Output

GPS-System

LAN 10/100/1000 Mbit/sec

LAN 10/100/1000 Mbit/sec, USB 2.0

Serial RS232 interface for data string with GPS-time information,

TTL input for 1PPS synchronization pulse

Mechanical Interfaces

Mounting of the Laser Scanner

Mounting of IMU sensor

mounting base block (with 8 x M8 thread inserts and 6x mounting slots)

3 x M6 thread inserts in the front and rear plate

(rigidly coupled with the internal mechanical structure)

General Technical Data

Power Supply Input Voltage

Current Consumption

Main Dimensions

Weight

Humidity

Protection Class

Max. Flight Altitude (operating)

Max. Flight Altitude (not operating)

Temperature Range

18 - 32 V DC

typ. 65 W

360.5 x 206 x 219 mm (L x W x H)

approx. 11.5 kg

max. 80 % non condensing @ +31°C

IP64, dust and splash-proof

16 500 ft (5 000 m) above MSL

18 000 ft (5 500 m) above MSL

-10°C up to +40°C (operation) / -20°C up to +50°C (storage)

PRR = 50 kHz

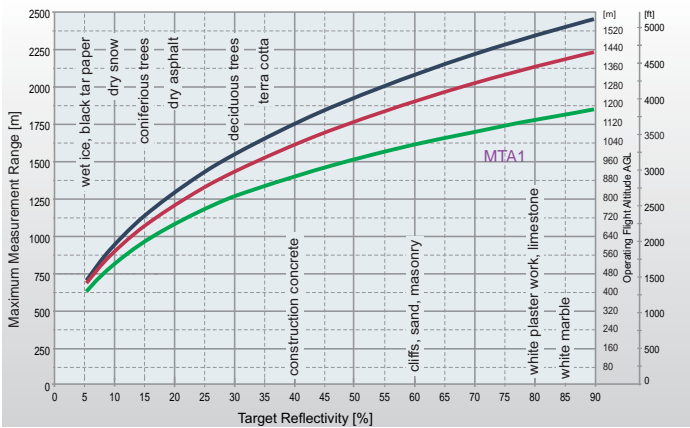

MTA1: no ambiguity / 1 transmitted pulse „in the air“

— @ visibility 23 km
— @ visibility 15 km
— @ visibility 8 km

PRR = 50 kHz

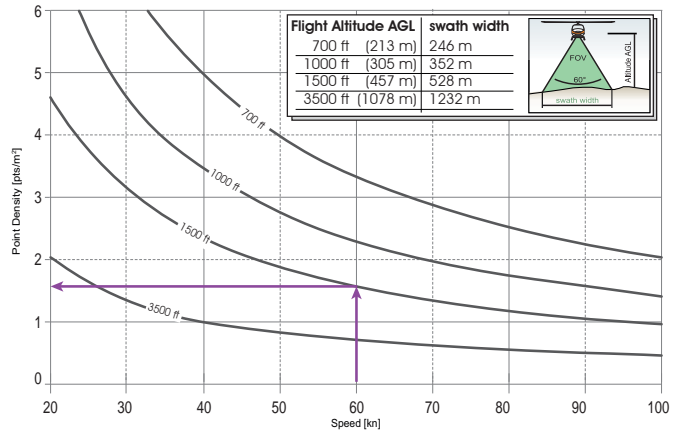

Example: VQ-480i at 50,000 pulses/second
Altitude = 1500 ft AGL, Speed = 60 kn
Resulting Point Density ~ 1.6 pts/m²

PRR = 100 kHz

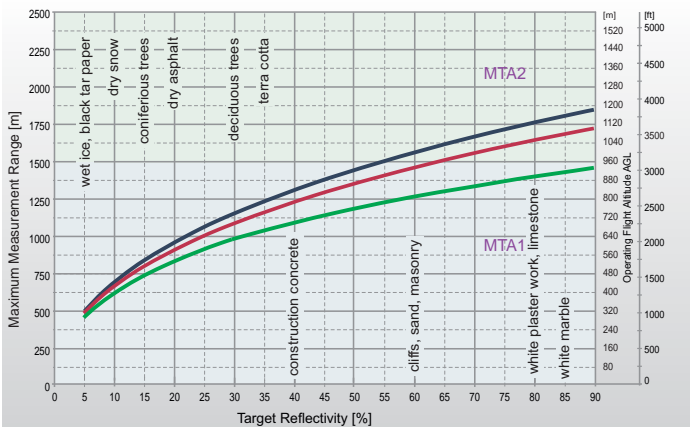

MTA1: no ambiguity / 1 transmitted pulse „in the air“
MTA2: 2 transmitted pulses „in the air“

— @ visibility 23 km
— @ visibility 15 km
— @ visibility 8 km

PRR = 100 kHz

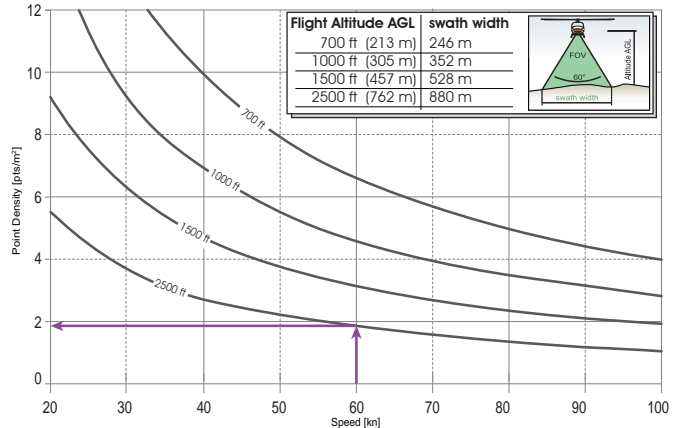

Example: VQ-480i at 100,000 pulses/second
Altitude = 2500 ft AGL, Speed = 60 kn
Resulting Point Density ~ 1.9 pts/m²

PRR = 200 kHz

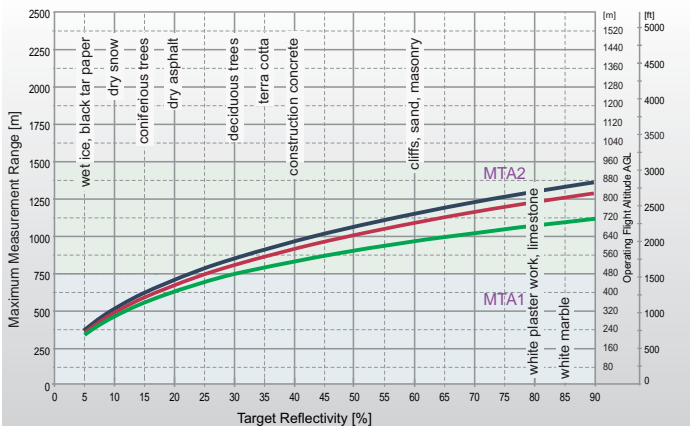

MTA1: no ambiguity / 1 transmitted pulse „in the air“
MTA2: 2 transmitted pulses „in the air“

— @ visibility 23 km
— @ visibility 15 km
— @ visibility 8 km

PRR = 200 kHz

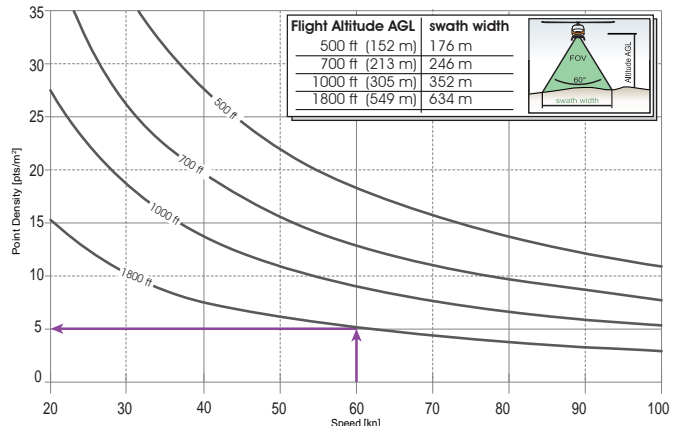

Example: VQ-480i at 200,000 pulses/second
Altitude = 1800 ft AGL, Speed = 60 kn
Resulting Point Density ~ 5 pts/m²

The following conditions are assumed for the Operating Flight Altitude AGL

- ambiguity resolved by multiple-time-around (MTA) processing & flight planning
- target size ≥ laser footprint
- scan angle 60°
- average ambient brightness
- roll angle +/-5°

Maximum Measurement Range & Point Density RIEGL VQ®-480i

PRR = 300 kHz

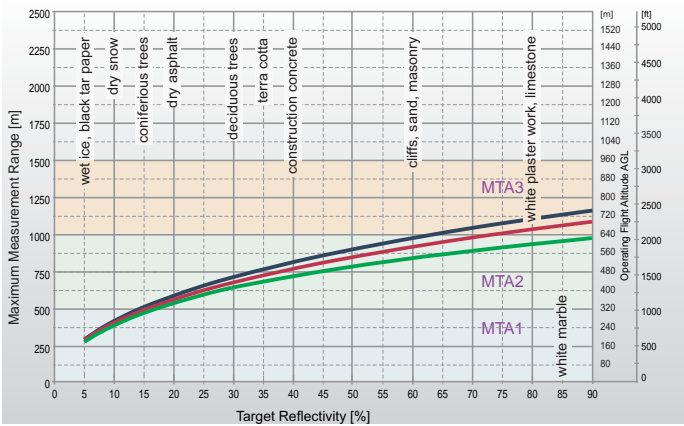

MTA1: no ambiguity / 1 transmitted pulse „in the air“
MTA2: 2 transmitted pulses „in the air“

— @ visibility 23 km
— @ visibility 15 km
— @ visibility 8 km

PRR = 300 kHz

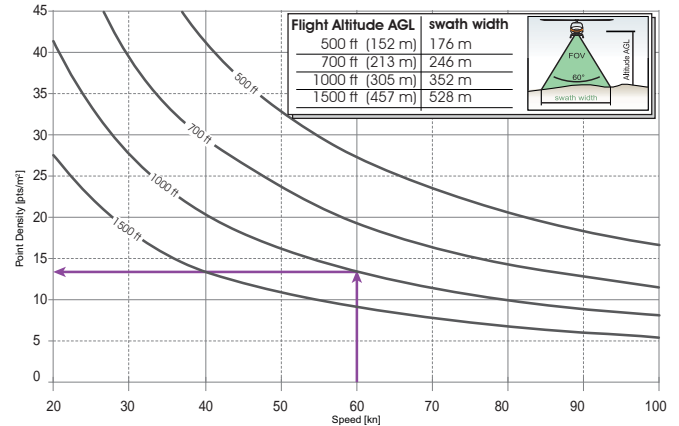

Example: VQ-480i at 300,000 pulses/second
Altitude = 1000 ft AGL, Speed = 60 km
Resulting Point Density ~ 13 pts/m²

PRR = 400 kHz

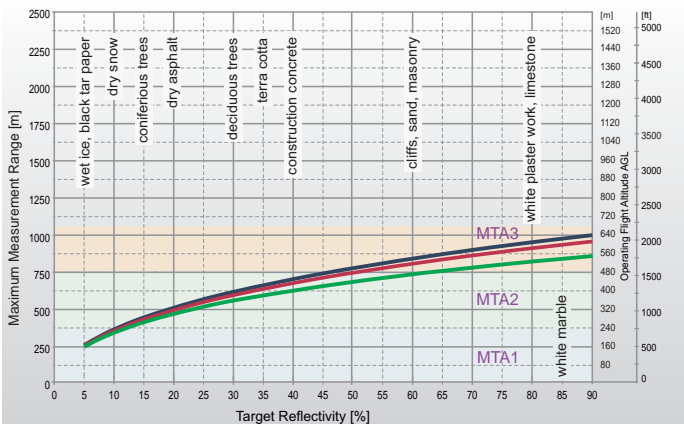

MTA1: no ambiguity / 1 transmitted pulse „in the air“
MTA2: 2 transmitted pulses „in the air“
MTA3: 3 transmitted pulses „in the air“

— @ visibility 23 km
— @ visibility 15 km
— @ visibility 8 km

PRR = 400 kHz

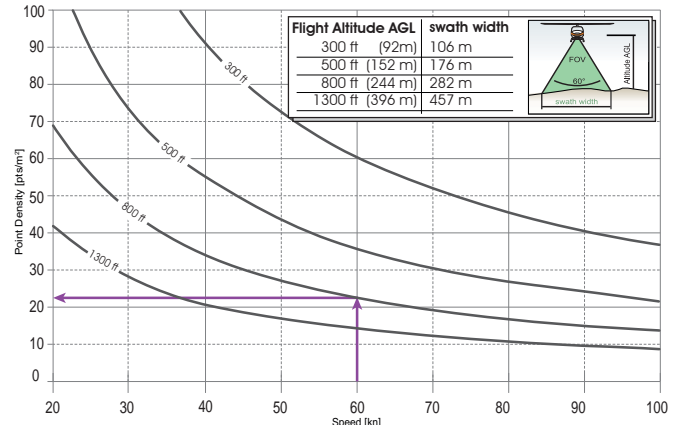

Example: VQ-480i at 400,000 pulses/second
Altitude = 800 ft AGL, Speed = 60 km
Resulting Point Density ~ 23 pts/m²

PRR = 550 kHz

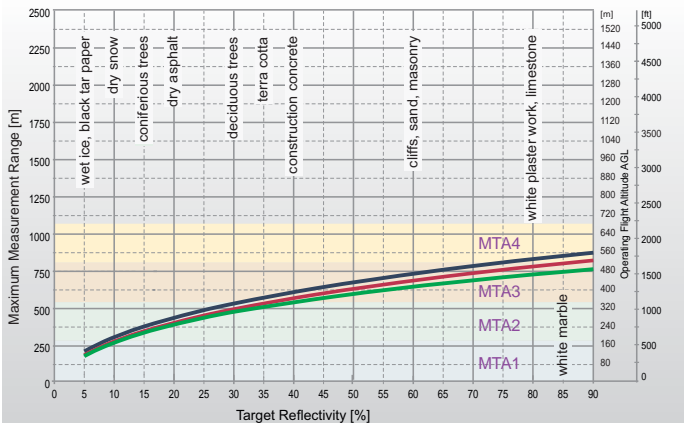

MTA1: no ambiguity / 1 transmitted pulse „in the air“
MTA2: 2 transmitted pulses „in the air“
MTA3: 3 transmitted pulses „in the air“
MTA4: 4 transmitted pulses „in the air“

— @ visibility 23 km
— @ visibility 15 km
— @ visibility 8 km

PRR = 550 kHz

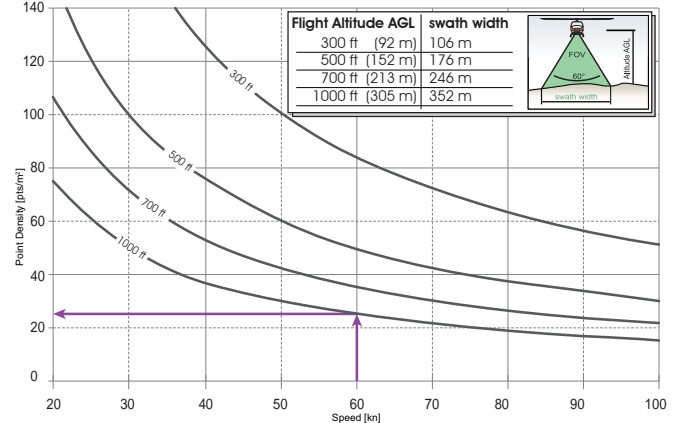

Example: VQ-480i at 550,000 pulses/second
Altitude = 1000 ft AGL, Speed = 60 km
Resulting Point Density ~ 25 pts/m²

The following conditions are assumed for the Operating Flight Altitude AGL

- ambiguity resolved by multiple-time-around (MTA) processing & flight planning
- target size ≥ laser footprint
- scan angle 60°
- average ambient brightness
- roll angle +/-5°

bottom view

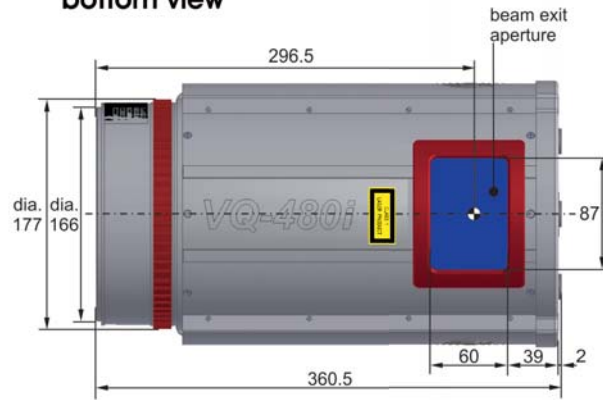

front view

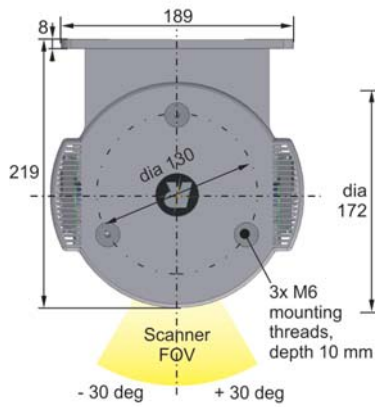

side view

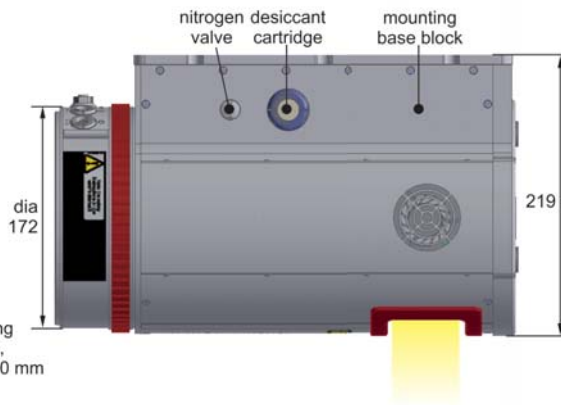

rear view

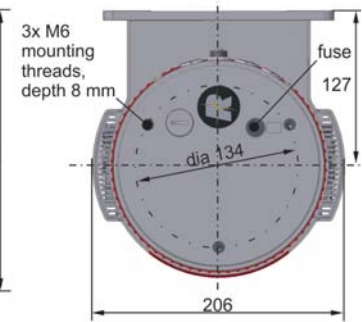

top view

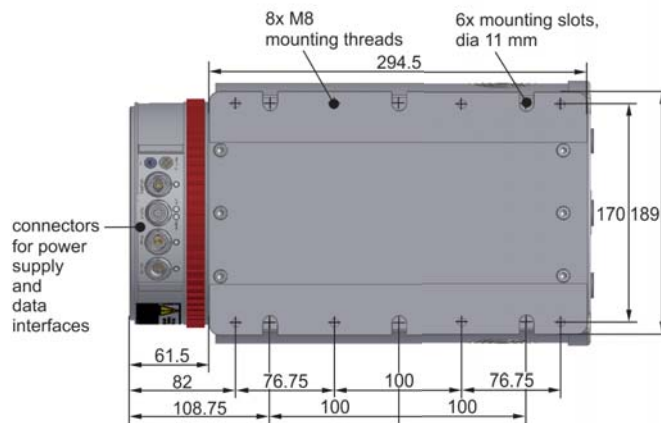

all dimensions in mm

⊙ origin of scanner's local coordinate system

Multiple-time-around Data Acquisition and Processing

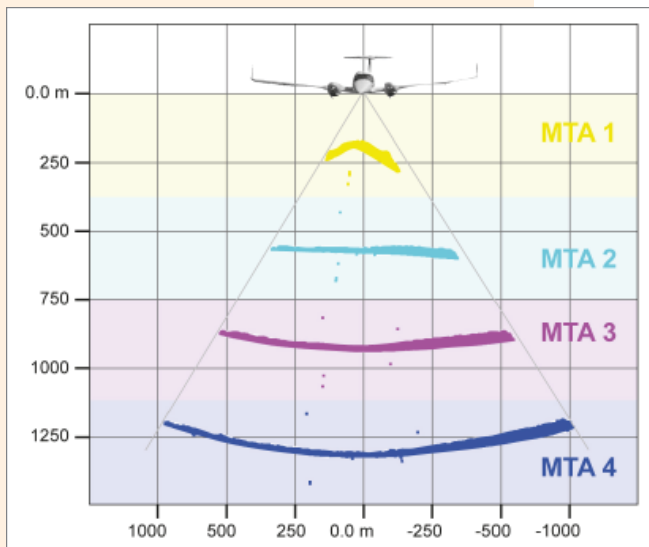

Example for a profile of scan data processed in MTA zones 1 to 4

In time-of-flight laser ranging a maximum unambiguous measurement range exists, which is defined by the laser pulse repetition rate and the speed of light. In case the echo signal of an emitted laser pulse arrives later than the emission of the subsequently emitted laser pulse, the range result becomes ambiguous - an effect known as „Multiple-Time-around“ (MTA).

The *RIEGL VQ-480i* allows ranging beyond the maximum unambiguous measurement range using a sophisticated modulation scheme applied to the train of emitted laser pulses. The dedicated post-processing software *RIMTA ALS* provides algorithms for multiple-time-around processing, which automatically assign definite range results to the correct MTA zones without any further user interaction required.



RIEGL Laser Measurement Systems GmbH
Riedenburgstraße 48
3580 Horn, Austria
Phone: +43 2982 4211 | Fax: +43 2982 4210
office@riegl.co.at
www.riegl.com

RIEGL USA Inc.
Orlando, Florida | info@rieglusa.com | www.rieglusa.com
RIEGL Japan Ltd.
Tokyo, Japan | info@riegl-japan.co.jp | www.riegl-japan.co.jp
RIEGL China Ltd.
Beijing, China | info@riegl.cn | www.riegl.cn

www.riegl.com